



next generation led

info@nextgenerationled.be
www.nextgenerationled.be
Tel + 32 53 71 09 42

SORAA ARC ADJUSTABLE Properties

- Lifespan L70 %: > 35.000 hr
- Available in recessed and semi-recessed version (4" or 6" terminal box required)
- One beam of light that causes no scattering light or false shadows
- IR and UV free
- The 9°, 10° and 15° versions are compatible with both the Arc accessories and the Soraa SNAP filters
- Light module is made of cast aluminum, transformer housing of extruded aluminum with a durable satin finish
- Available in black, white and silver
- Less than 30% flicker which reduces the eyestrain
- Environment friendly: no mercury or toxic gasses
- Instant switch-on regardless of temperature or humidity
- Equal light distribution and high uniformity
- Warranty : 5 year



CRI 95

35.000 u.

R9 > 95

1 light-beam

Specifications

Power	11 W	18 W	20 W
Color temperature	2700 - 3000 - 4000K		
Beam angle	10° - 15° - 25° - 36°		9° - 25° - 36° - 60°
Luminous intensity	475lm	835 - 950lm	900 - 995lm
Powerfactor	> 0.93		
Dimmable	<1%		
Temp. in use	-40°C to 25°C		
Dimensions	78,5mm x 53,1mm		110mm x 60,8mm
SNAP Compatible	SNAP compatible with 10° - 15° and 9°		

Application

Shop, showroom, gallery, meeting room, hospital, residential applications ...

Updated: October 2017

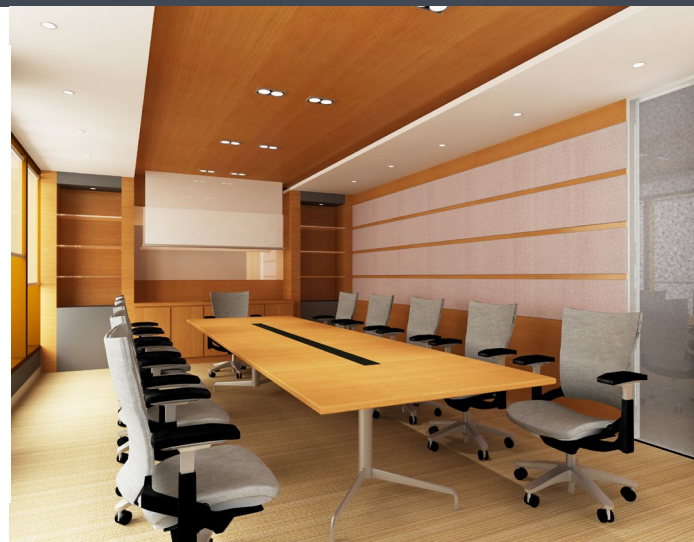
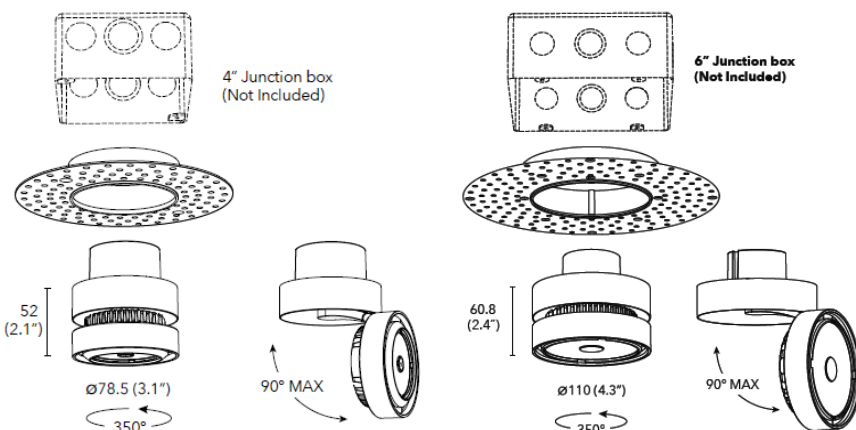

Snap System

Accessories are important tools that allow lighting designers to create or optimize light moods in a simple and fast way. Examples of typical accessories are: grids and filters to reduce glare; linear light patterns.

BEAM SPREADER

17° - 25° - 36° - 60°

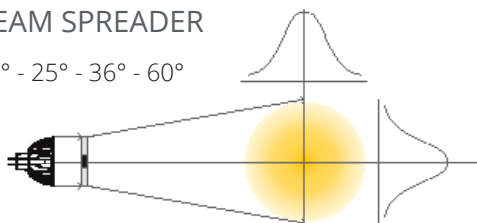

De Beam Spreaders verwijderen de stralenbundel van 10° naar respectievelijk 17°, 25°, 36° of 60°

LINEAR LENS

10° - 36°

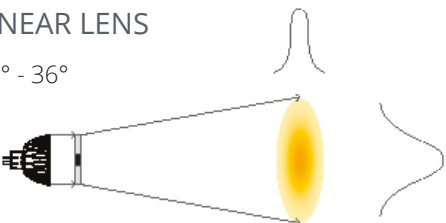

With the Linear Lens you will get an asymmetrical beam (10° in one, 36° in other direction), ideal for illuminating narrow objects or entire walls

LOUVRE SNAP

40°

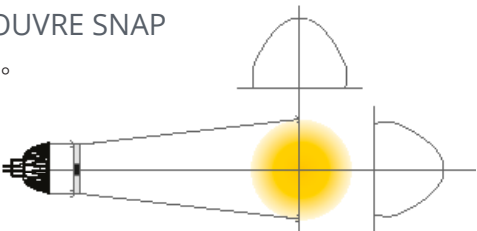

The honeycomb structure of the Louvre Snap directs the beam and so doing removes glare

CCT SHIFTER

1/4 - 1/2 - 3/4



The CCT Shifter changes the color temperature, resulting in a warm, dimmed effect. Often used in restaurants and reception rooms

FLAT TOP SNAP



Provides even illumination from the center to the edges. Eliminates video camera saturation, for use in applications such as camera surveillance

AIM SNAP

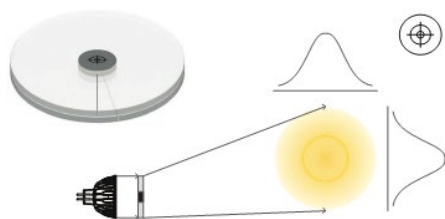

Designed with two lenses, the Aim Snap flexes the light beam from 0 degrees to a maximum deflection angle of 20 degrees while maintaining uniform color and shape

Spectrum

Due to the unique production technology, the color spectrum emphasizes deep red, cyan and even the natural violet. On the other hand, the blue peaks are suppressed in the spectrum, which makes white objects really white.

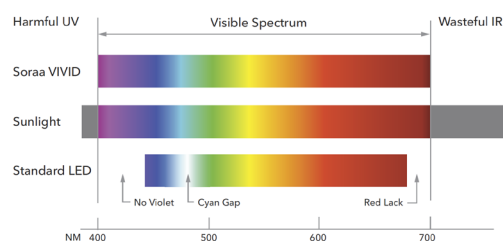

Shadow

The Soraa works with a single beam of light, resulting in no deformed shadows or stray light.



REFERENCE	WATT	CRI	LUMEN	KLEUR	BUNDEL	DIMBAAR
112-0049	11W	95	475lm	2700K	10°	YES
112-0050	18W	95	835lm	2700K	15°	YES
112-0051	18W	95	950lm	2700K	25°	YES
112-0052	18W	95	950lm	2700K	36°	YES
112-0053	11W	95	475lm	3000K	10°	YES
112-0054	18W	95	835lm	3000K	15°	YES
112-0055	18W	95	950lm	3000K	25°	YES
112-0056	18W	95	950lm	3000K	36°	YES
112-0057	11W	95	475lm	4000K	10°	YES
112-0058	18W	95	835lm	4000K	15°	YES
112-0059	18W	95	950lm	4000K	25°	YES
112-0060	18W	95	950lm	4000K	36°	YES
112-0061	20W	95	900lm	2700K	9°	YES
112-0062	20W	95	995lm	2700K	25°	YES
112-0063	20W	95	995lm	2700K	36°	YES
112-0064	20W	95	995lm	2700K	60°	YES
112-0065	20W	95	900lm	3000K	9°	YES
112-0066	20W	95	995lm	3000K	25°	YES
112-0067	20W	95	995lm	3000K	36°	YES
112-0068	20W	95	995lm	3000K	60°	YES
112-0069	20W	95	900lm	4000K	9°	YES
112-0070	20W	95	995lm	4000K	25°	YES
112-0071	20W	95	995lm	4000K	36°	YES
112-0072	20W	95	995lm	4000K	60°	YES

SNAP ACCESSOIRES

REFERENCE	MODULATOR	TYPE	LED-LAMP
900-0100	BEAM SPREADER	25°	SORAA AR & MR16 & GU10
900-0101	BEAM SPREADER	36°	SORAA AR & MR16 & GU10
900-0102	BEAM SPREADER	60°	SORAA AR & MR16 & GU10
900-0103	LINEAR LENS	10°-25°	SORAA AR & MR16 & GU10
900-0104	LINEAR LENS	10°-36°	SORAA AR & MR16 & GU10
900-0105	FLAT TOP	25°-25°	SORAA AR & MR16 & GU10
900-0106	FLAT TOP	36°-36°	SORAA AR & MR16 & GU10
900-0107	LOUVRE	40°	SORAA AR & MR16 & GU10
900-0108	CCT SHIFTER	1/4	SORAA AR & MR16 & GU10
900-0109	CCT SHIFTER	1/2	SORAA AR & MR16 & GU10
900-0110	CCT SHIFTER	3/4	SORAA AR & MR16 & GU10

