

Synchronized Version Tri-level Control (Corridor function)

Model: HC419V

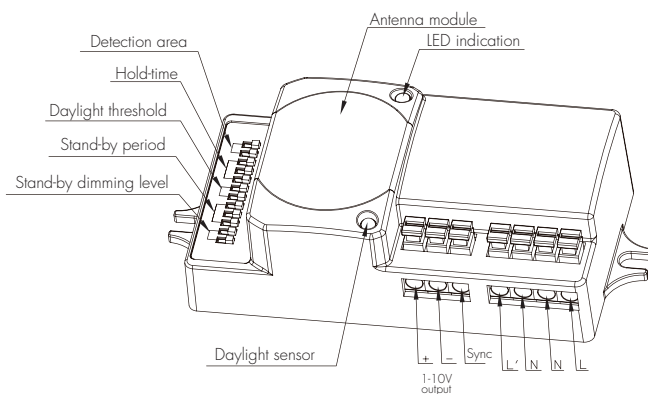

Model: HC419V (120-277Vac)

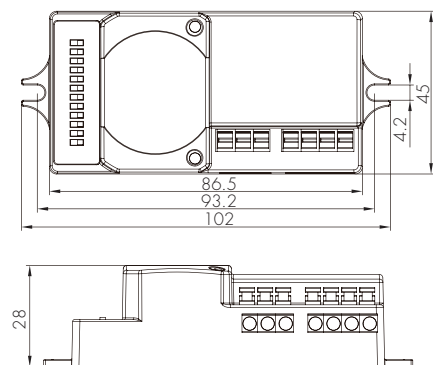

Mechanical structure (mm)

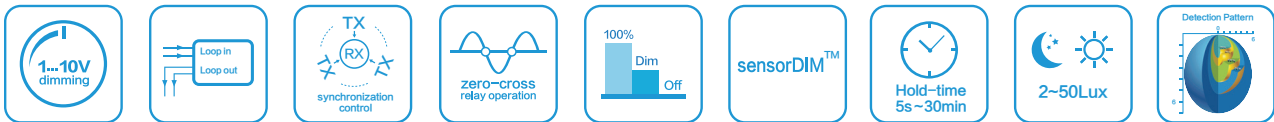

In many cases, several sensors are connected together to control the same fixture, or to trigger on each other, the sudden on/off may cause huge magnetic pulse and mis-trigger the sensor. Hytronik synchronized sensor HC419V is specially designed for these applications with 1-10V output which employs a strong software to overcome the magnetic interferences.

Product Functions and Features

In a lot of buildings, there is a need that the moving object in corridor or undercover garage can trigger a transmitter luminaire with connected receiver luminaires from more than one direction. Every transmitter luminaires (containing the sensor) should be able to trigger the whole installation whether it's an on/off or dimming installation.

See the example below that there are several exits /entrances to the corridor, no matter which sensor at exit /entrance is triggered, the luminaires in the group will light up.

1 Synchronized control function

2 Zero-cross relay operation

3 Wire loop-in and loop-out

4 Tri-level control (corridor function)

Same as Tridonic excel control gear, Hytronik builds this function inside the motion sensor to achieve tri-level control, for some areas require a light change notice before switch-off.

It offers 3 levels of light: 100%-->dimmed light (10%, 20%, 30%, 50% optional)-->off; and 2 periods of selectable waiting time: motion hold-time and stand-by period; selectable daylight threshold and freedom of detection area.

With sufficient natural light, the light does not switch on when presence detected.

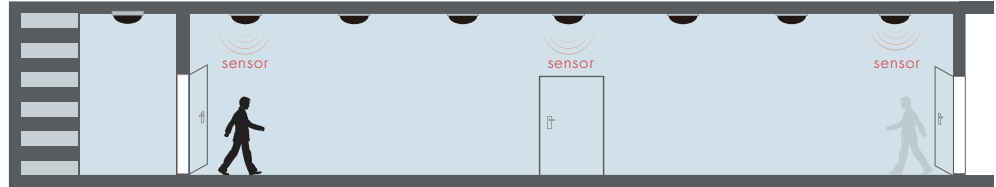

With insufficient natural light, the person comes from any direction, the group of lamps switch on.

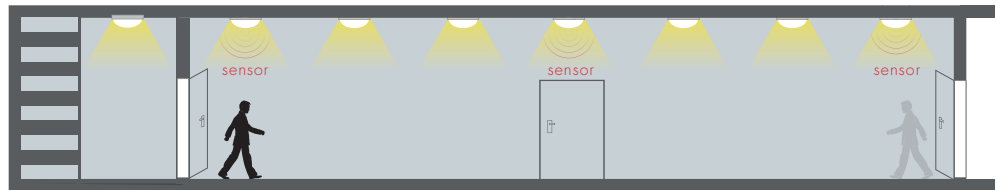

After the hold-time, the whole group of lamps dim to pre-defined dimming level when no motion is detected.

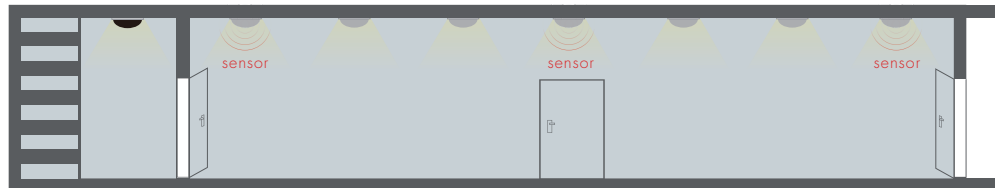

After the stand-by period, the whole group of lamps switch off automatically.

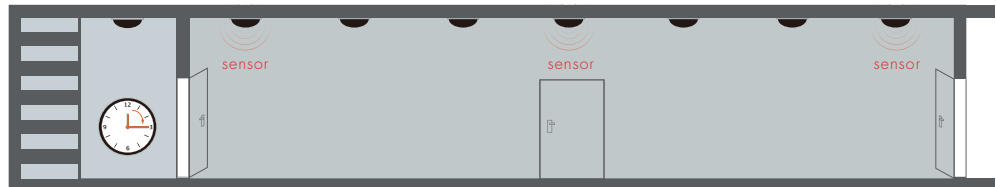

5 Wiring diagram

1 sensor controls a group of ballast /driver

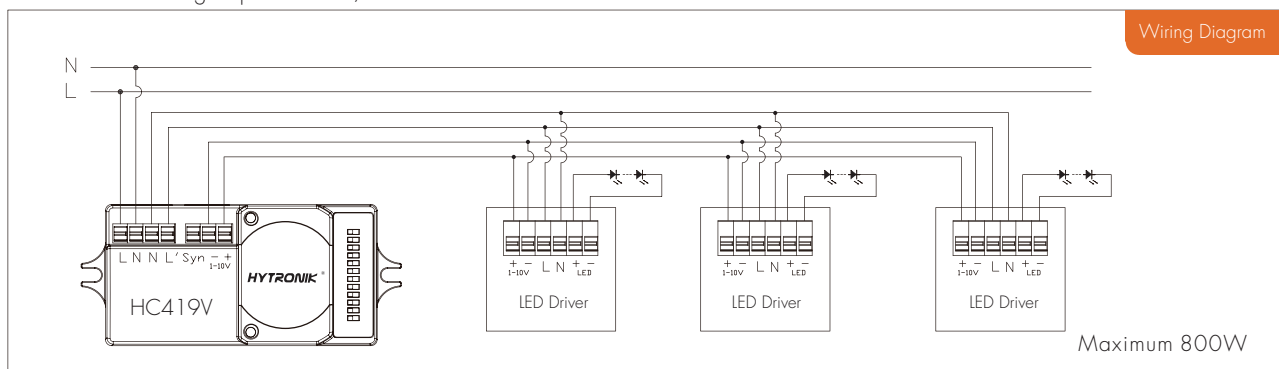

Multiple sensors control the same group of ballast /driver

Wiring Diagram

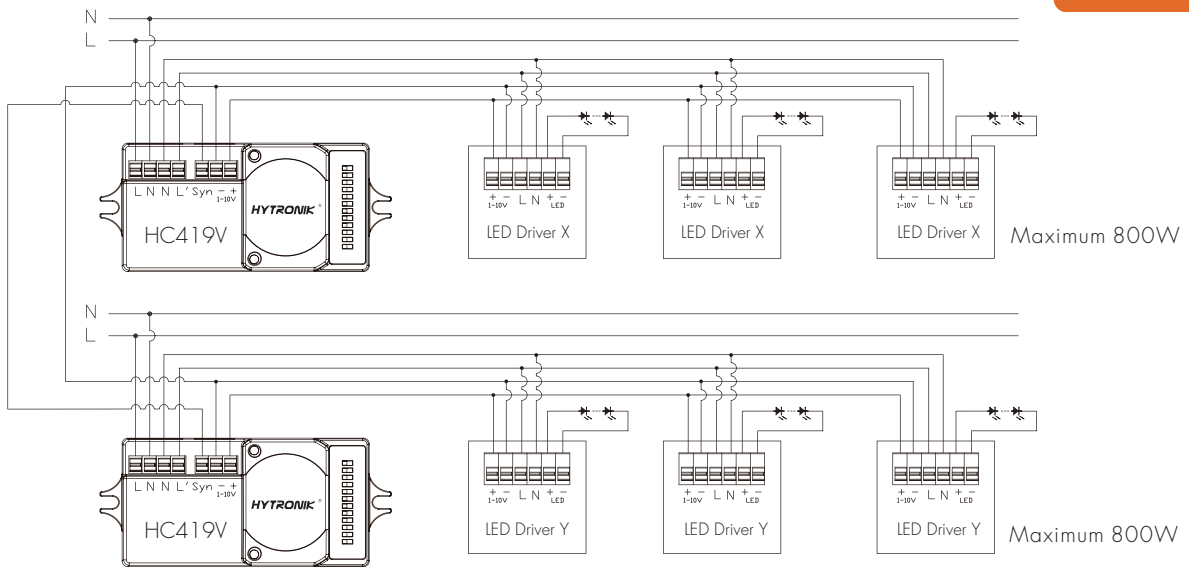

Note: this 1-10V output is isolated, SELV output. Do not connect the 1-10V terminals on driver X to Driver Y.

Detection Pattern

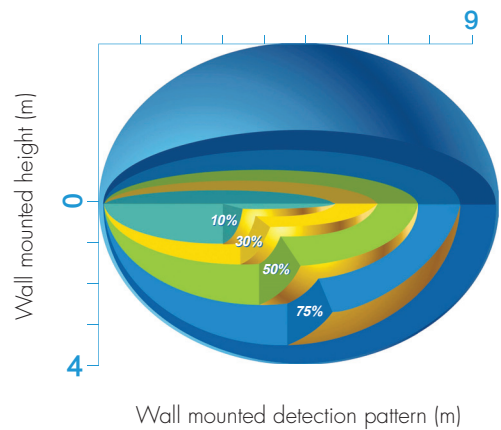
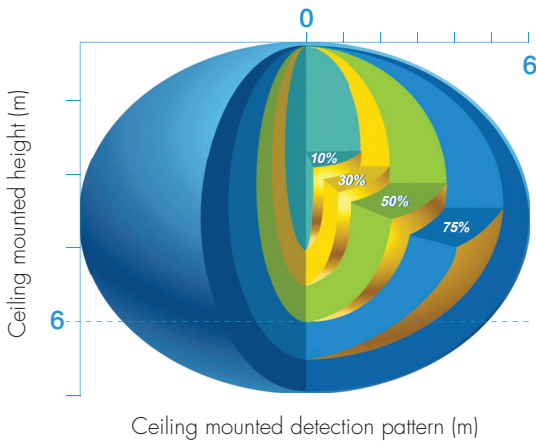

Settings

1 Detection area

Detection area can be reduced by selecting the combination on the DIP switches to fit precisely for each specific application.

	1	2	
I	●	●	100 %
II	●	○	75 %
III	○	●	50 %
IV	○	○	10 %

- I – 100%
- II – 75%
- III – 50%
- IV – 10%

2 Hold-time

Hold-time means the time period you would like to keep the lamp on 100% after the person has left the detection area.

	1	2	3	
I	●	●	●	5s
II	●	●	○	30s
III	●	○	●	1min
IV	●	○	○	5min
V	○	●	●	10min
VI	○	●	○	20min
VII	○	○	○	30min

- I – 5s
- II – 30s
- III – 1min
- IV – 5min
- V – 10min
- VI – 20min
- VII – 30min

3 Daylight sensor

The daylight threshold can be set on DIP switches, to fit for particular application.

	1	2	
I	●	●	Disable
II	●	○	50Lux
III	○	●	10Lux
IV	○	○	2Lux



I – Disable
II – 50Lux
III – 10Lux
IV – 2Lux

4 Stand-by period (tri-level control)

This is the time period you would like to keep at the low light output level before it is completely switched off in the long absence of people.

Note: "0s" means on/off control;

"+ ∞" means bi-level control, fixture never switches off.

	1	2	3	
I	●	●	●	0s
II	●	●	○	10s
III	●	○	●	1min
IV	●	○	○	5min
V	○	●	○	10min
VI	○	●	●	30min
VII	○	○	●	1h
VIII	○	○	○	+∞



I – 0s
II – 10s
III – 1min
IV – 5min
V – 10min
VI – 30min
VII – 1h
VIII – +∞

5 Stand-by dimming level

This is the dimmed low light output level you would like to have after the hold-time in the absence of people.

	1	2	
I	●	●	10%
II	●	○	20%
III	○	●	30%
IV	○	○	50%



I – 10%
II – 20%
III – 30%
IV – 50%

Technical Data

Operating voltage	120-277Vac
Switched power (Capacitive load)	Max. 400W@120Vac; 1000W@277Vac
Stand-by power	<0.5W
Warm time	20s
Detection area	10/50/75/100%, can be customized
Hold-time	5s/30s/1min/5min/10min/20min/30min
Stand-by period	0s/10s/1min/5min/10min/30min/1h/+∞
Stand-by dimming level	10%/20%/30%/50%
Daylight threshold	2~50Lux, disable
Sensor principle	HF (microwave) motion detector
HF (microwave) frequency	5.8GHz+/-75MHz
HF (microwave) power	<0.2mW
Detection range	Max. (∅xH): 12m x 6m
Detection angle	30°~150°
Mounting height	Max. 6m
Operating temperature	-35°C ~ +70°C
Max. case temperature (Tc)	80°C
IP rating	IP20
Certificate	cULus listed, ETL, FCC